

SUBARU IMPREZA WRC 2007 BODY SHELL

Official Licensed Product

NO.48761

killerbody™

1/10 RC PLANNING INSTRUCTION SHEET

This body can be used with 1/10 electric touring car chassis (Long Wheelbase: 257mm Width: 190mm)

Before beginning assembly, please read these instructions thoroughly!

● Symbols used throughout the instruction manual, comprise:



Cut off shaded portion.



5mm
Drill holes with
the specified diameter.



Pay close attention here!



Must be purchased
separately.



Assemble left and right sides
the same way.

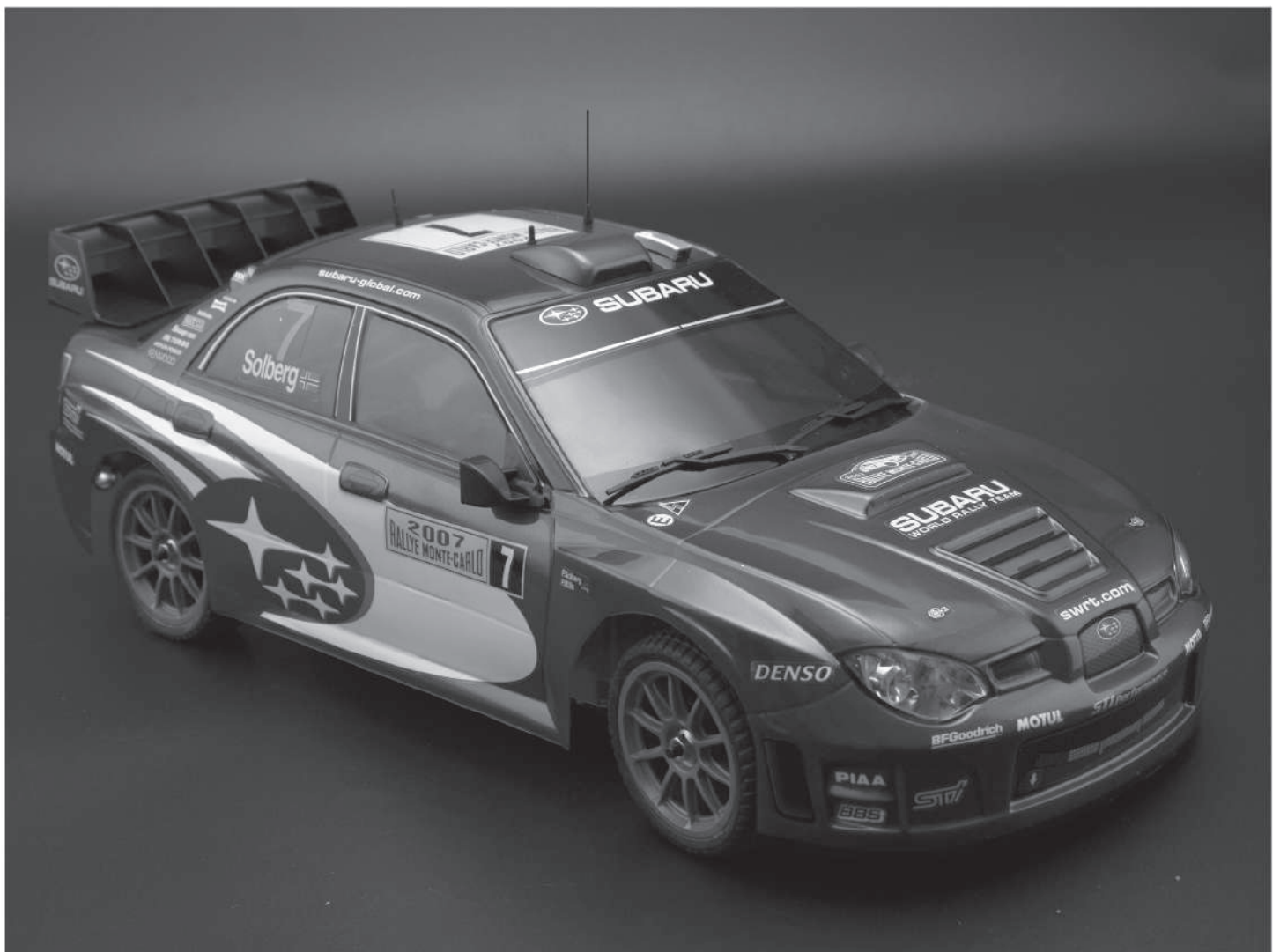

● Before Assembly

Decoration Body

- ▶ In the case of a decoration body, please assemble it according to the contents showed.

When making the window transparent

- ▶ If you want to make the window transparent with a non decoration body, please assemble it according to the contents showed.

Non Decoration Body

- ▶ In the case of non decoration body, please assemble it according to the contents showed.





When loading LED lights

- ▶ If you want to load LED lights with a non decoration body, please assemble it according to the contents showed.

PARTS

PC body	-----	X1
ABS parts	-----	X1
ABS chromed parts	-----	X1
Decal sheet	-----	X1
Window masks	-----	X1
Antenna	-----	X1

PARTS BAG

	LED stopper	-----	X15		Screw 2.3X6mm	-----	X21
	Clip	-----	X2		Double-sided tape	-----	X1
	O-Ring	-----	X2		Aluminum tape	-----	X1

PLASTIC PARTS

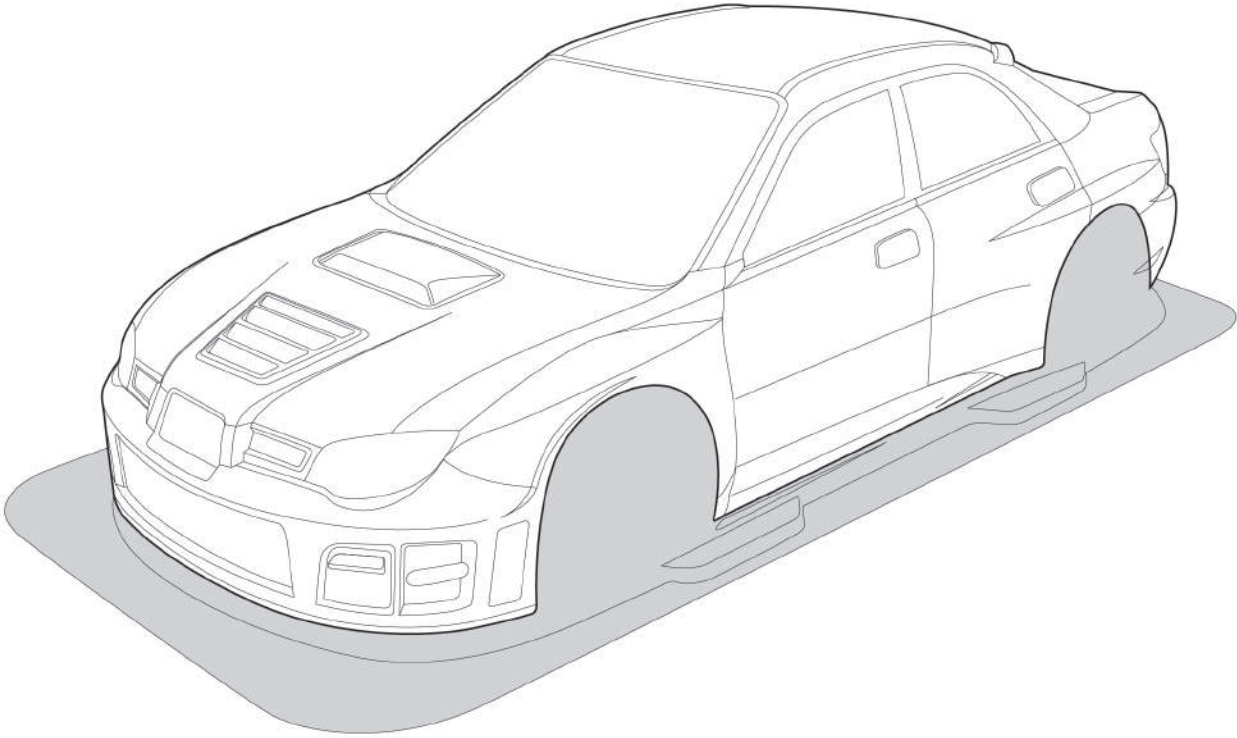

A ABS part-1
Electroplate

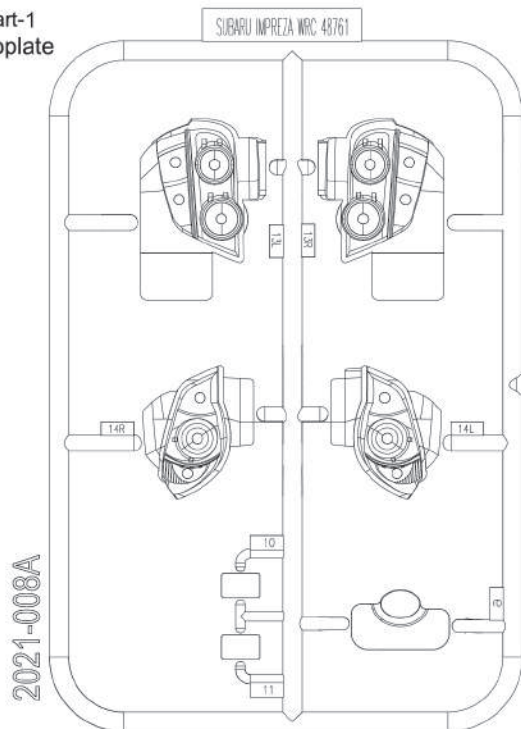

B ABS part-2

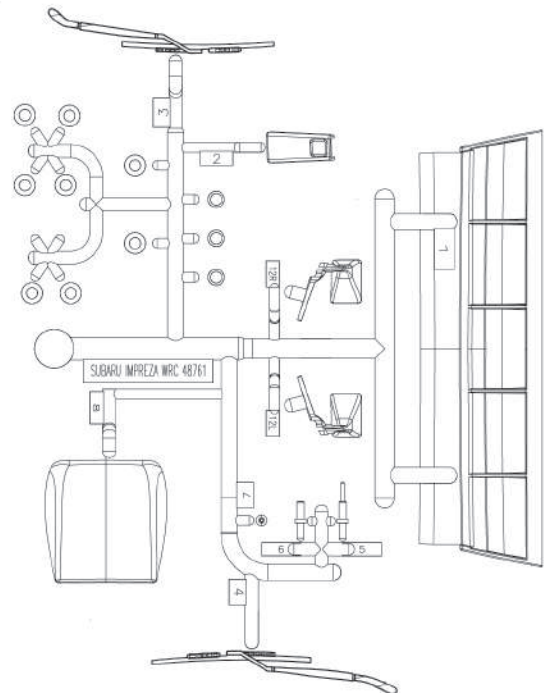

2 Cutting

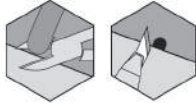

Cut and smooth rough edge.

A B

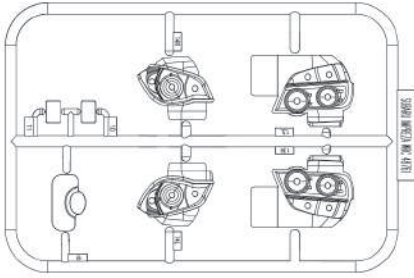

3 Painting

Paint spray color what you prefer on these parts. It is advised use the recommended spray color as below.

B

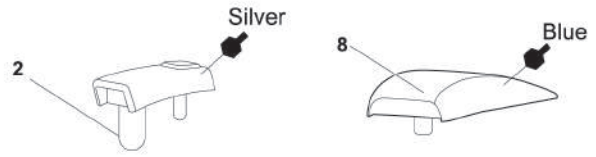

4 Painting

1 Before painting, use a neutral detergent to remove any oil residues and dirt.

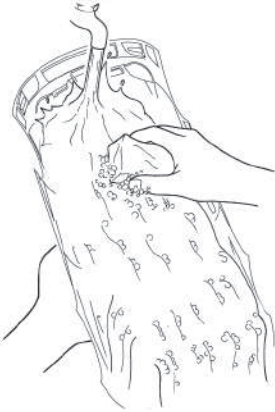

2 Mask the parts from inside.

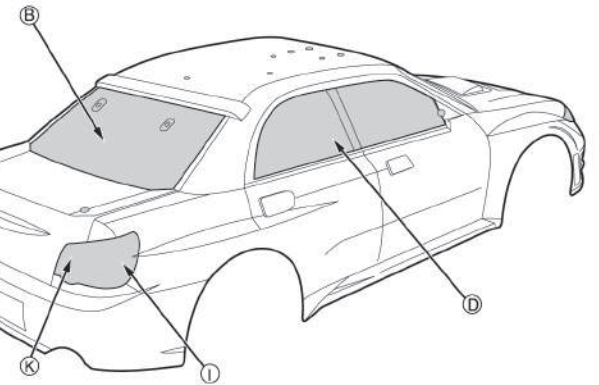
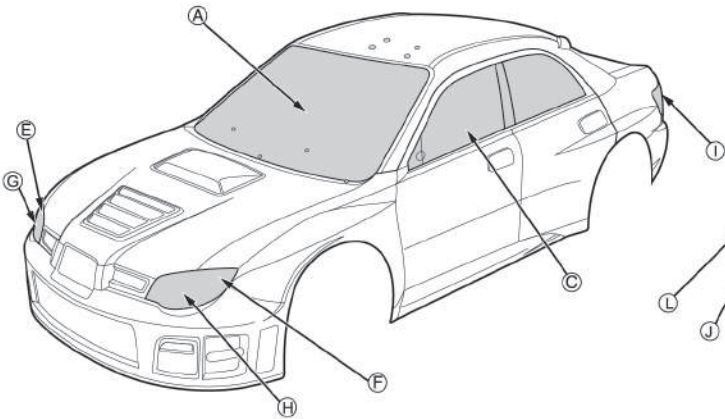
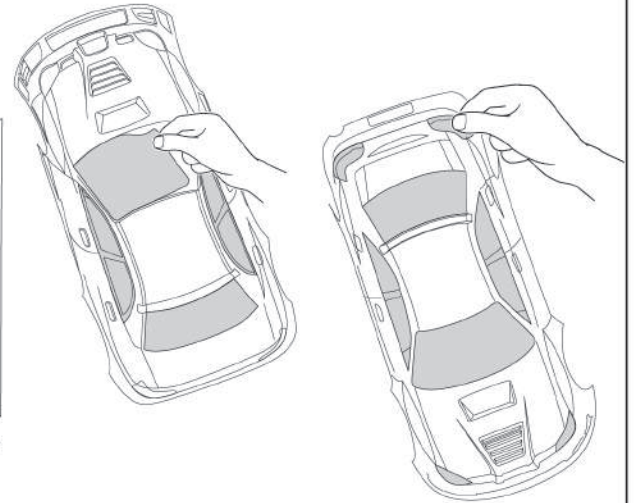
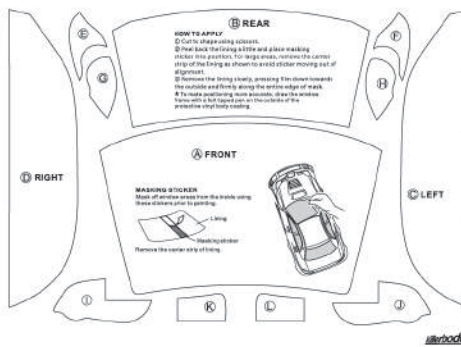

3 Paint spray color from the inside.

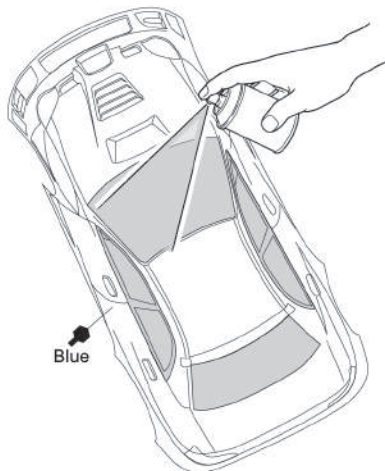

4 After painting, remove the protective film from the body shell.



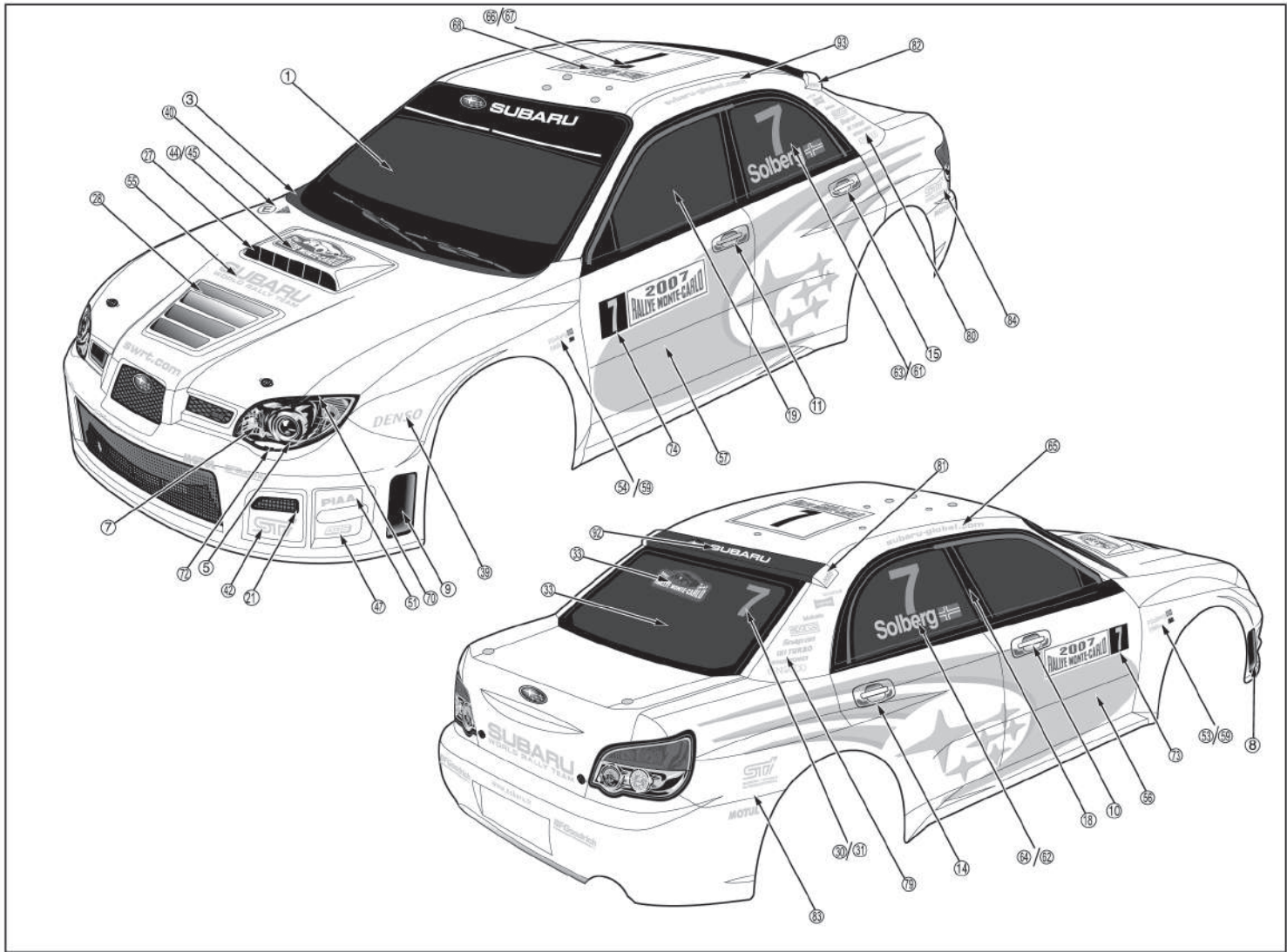

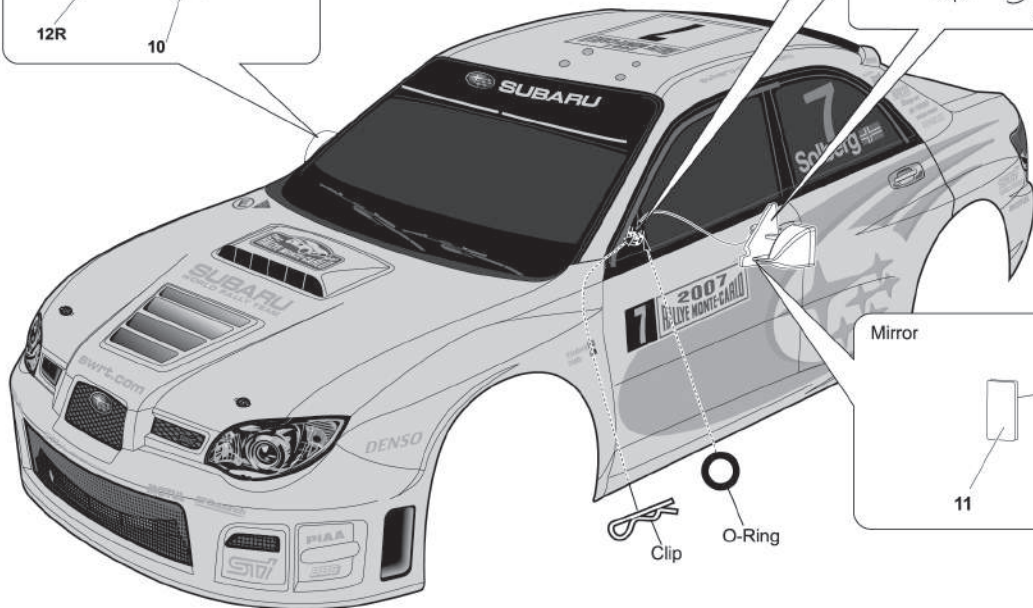
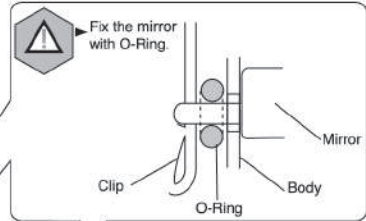
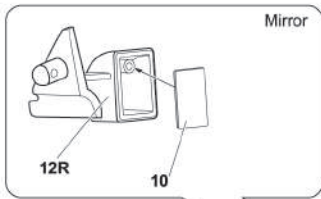

6 Assembling

- Clip -X2
- O-Ring -X2

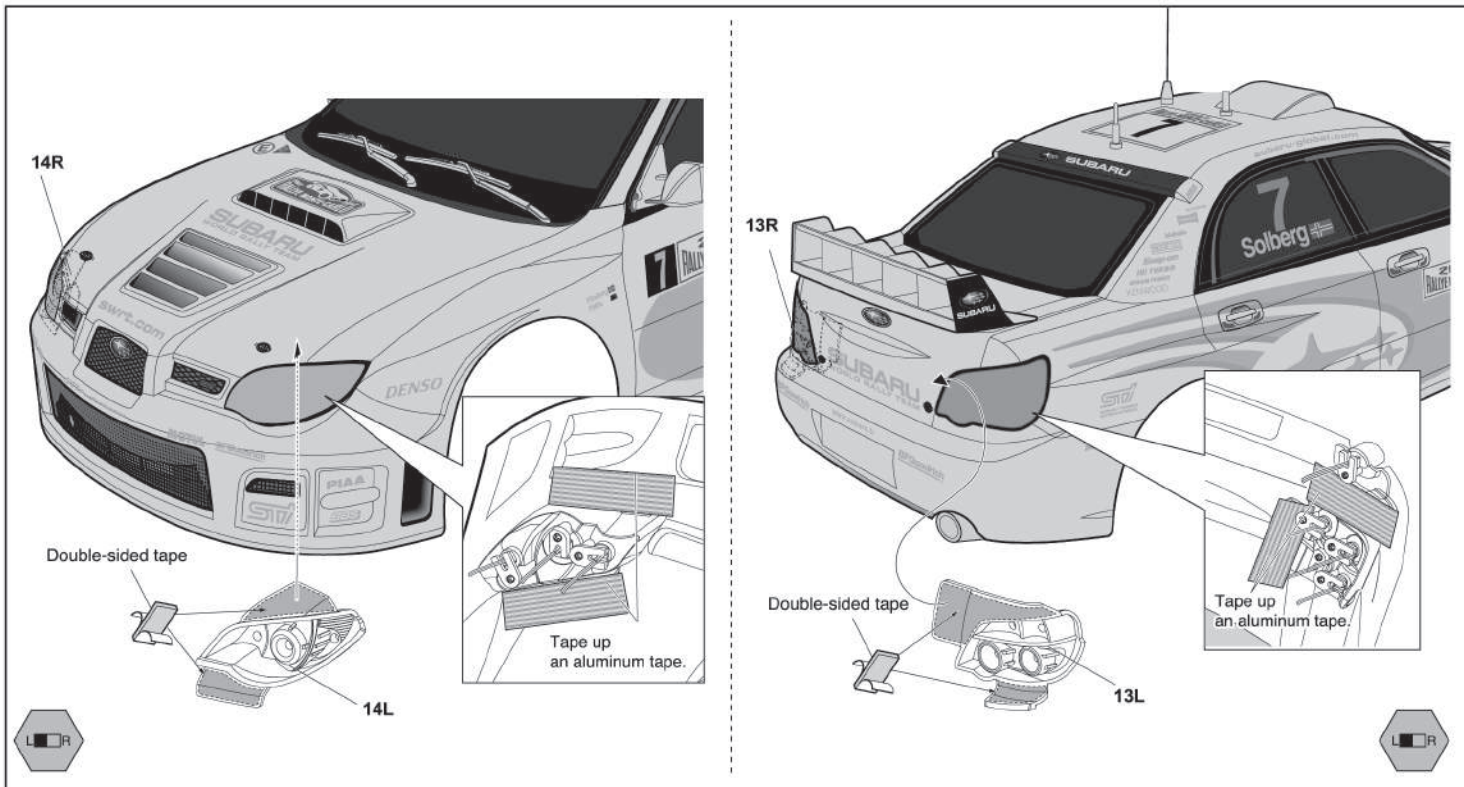



9 Finished

 For safety reasons, always fit the body shell when running your car.

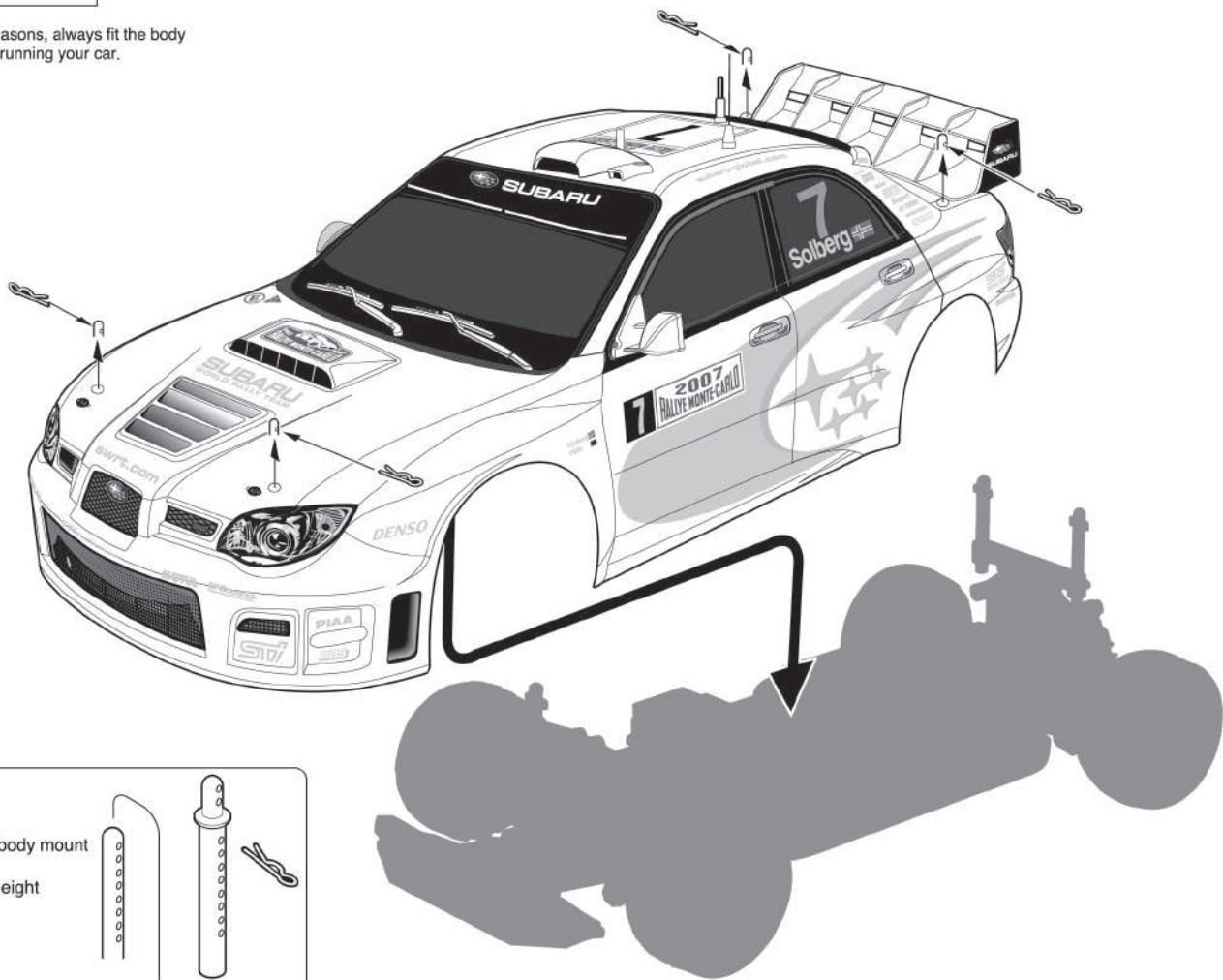

 Use the extension body mount (sold separately) if the body mount height is not enough.