

● Symbols used throughout the instruction manual, comprise:



Cut off shaded portion.



5mm  
Drill holes with  
the specified diameter.



Pay close attention here!



Must be purchased  
separately.



Assemble left and right sides  
the same way.

### PARTS

PS PARTS ----- X1

PS PARTS

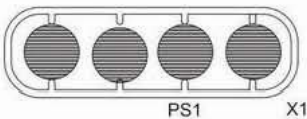

PS1 X1

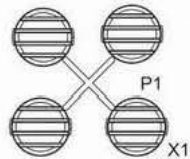

P1 X1

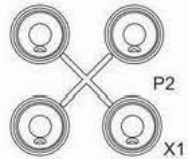

P2 X1

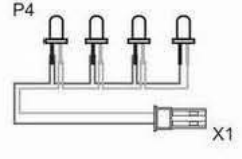

P4 X1

PARTS BAG

TAPPING SCREW ----- X6

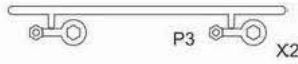

P3 X2



P5 X1

### 1 Plastic Parts

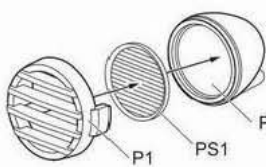

2 x 7mm F/H TP Screw  
----- 4

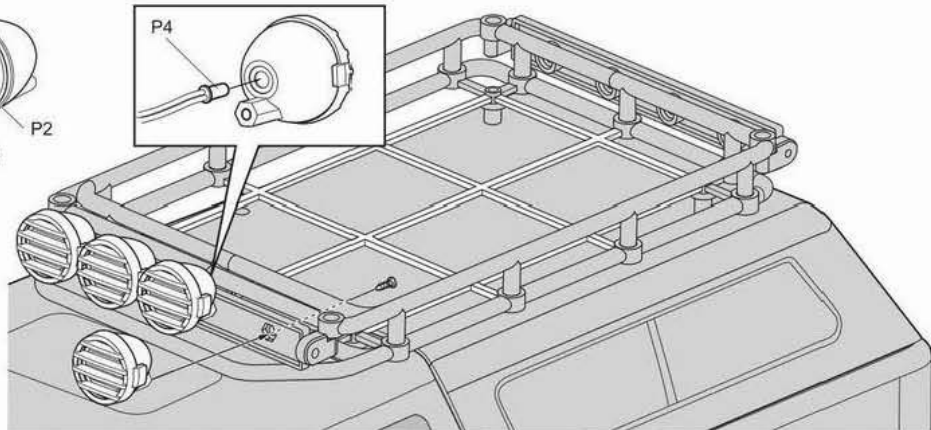

### 2 Finished

Two installation methods for reference:

