

PARTS

 X4

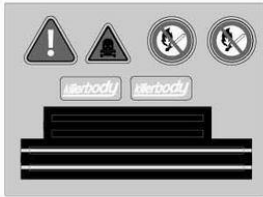

Decal sheet

PLASTIC PARTS

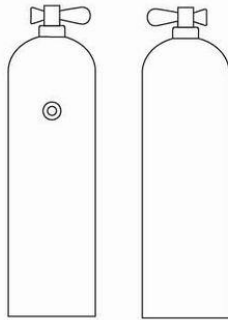

Plastic oxygen bottle X2

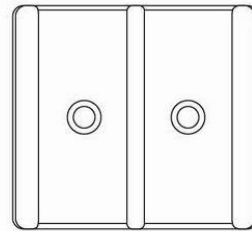

1 Painting

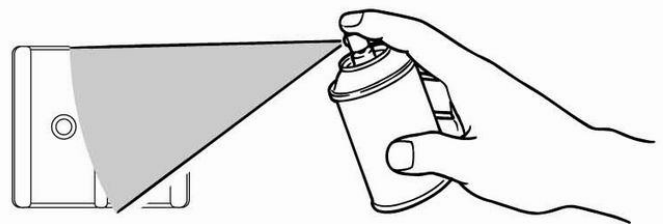
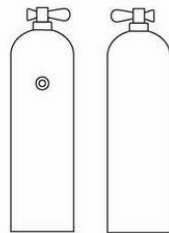

2 Assembling

 Fixing with glue

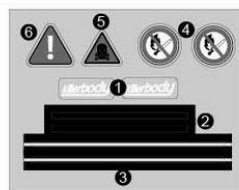
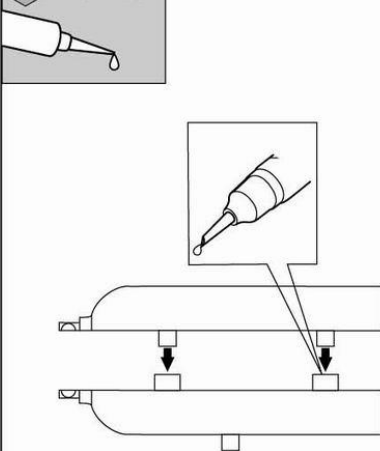

Decal sheet

